



**European Union**

European Structural  
and Investment Funds



OPERATIONAL PROGRAMME  
TRANSPORT AND  
TRANSPORT INFRASTRUCTURE



# XVI Monitoring Committee of Operational Programme on Transport and Transport Infrastructure 2014 - 2020



**European Union**

European Structural  
and Investment Funds



# BPI Co. Projects



**BULGARIAN PORTS  
INFRASTRUCTURE Co.**

- 1 BG16M1OP001-4.001-0005** Technical assistance for preparation and implementation of project Delivery, Installation and Implementation of the port reception facilities (PRF) in the Bulgarian public transport ports of national importance – Priority Axis 4
- 2 BG16M1OP001-4.001-0015** Delivery, installation and commissioning of port reception facilities (PRF) in Bulgarian public transport ports of national importance – Priority Axis 4
- 3 BG16M1OP001-5.001-0025** Specialized trainings to increase the capacity of the employees of the Bulgarian Ports Infrastructure Company (BPI Co.) as Beneficiary under Operational Programme on Transport and Transport Infrastructure (OPTTI) 2014-2020 – Priority Axis 5
- 4 BG16M1OP001-5.001-0026** Provision of technical assistance for project preparation for the next programming period 2021-2027 – Priority Axis 5



**European Union**

European Structural  
and Investment Funds

## PROJECTS UNDER IMPLEMENTATION PRIORITY AXIS 4



**BG16M1OP001-4.001-0005** Technical assistance for preparation and implementation of project Delivery, Installation and Implementation of the port reception facilities (PRF) in the Bulgarian public transport ports of national importance

**Grant Contract №:** DOPTTI-3 of 20.02.2018

**Grant amount:** 1 320 000,00 BGN

**Term of Project completion:** 31.08.2023

**Main objective of the Project:** To provide highly qualified and specific consultancy assistance for the preparation and implementation of an investment project aiming to improve the management of the environment in the field of water transport.



**BULGARIAN PORTS  
INFRASTRUCTURE Co.**

# PROJECTS UNDER IMPLEMENTATION PRIORITY AXIS 4

## CONTRACT SIGNED WITH A CONTRACTOR:

Contract N°DEP-27 / 26.10.2018 with “PORT CONSULT” DZZD amounting to BGN 1 193 000,00 for the implementation of the main activities of the project:

 Activities 1, 2 and 3 of the contract are fulfilled;

 Activity 4 is under implementation and envisages:

monitoring and control during the delivery and installation of equipment; monitoring and control during the implementation of the IIP; organization of training, meetings and seminars

**The activities under the contract have been completed at 80%.**

**Total verified project expenditures as of 15.11.2021: 933 124.77 BGN**





**European Union**  
European Structural  
and Investment Funds

# PROJECTS UNDER IMPLEMENTATION

## PRIORITY AXIS 4





**BG16M1OP001-4.001-0015** Delivery, installation and commissioning of port reception facilities (PRF) in Bulgarian public transport ports of national importance



Annex 1 DOPTTI-8/08.11.2021  
**Grant Contract №:** DOPTTI-6 of 07.10.2020  
**Grant amount:** 12 782 782,88 BGN  
**Term of Project completion:** 30.10.2022

**Main objectives of the Project:**

-  Improving transport management through the implementation of innovative systems;
-  Promoting sustainable transport and removing undercapacity in key network infrastructures





**European Union**  
European Structural  
and Investment Funds

# PROJECTS UNDER IMPLEMENTATION

## PRIORITY AXIS 4



### CONTRACTS SIGNED WITH A CONTRACTOR:

Contract №DEP-19/18.09.2020 with “IDEA SERVIZ” LTD amounting to BGN 64 730,00 for Delivery, installation and commissioning of port reception facilities (PRF) in Bulgarian public transport ports of national importance.

 With protocol from 21.07.2021. the Contractor has handed over and put into operation the facilities, according to art. 3, para 2 of the concluded contract № DEP-19 from 18.09.2020.

 The contract has been fulfilled.



Contract №DEP-3/07.04.2020 with “Lamor Corporation Ab” amounting to BGN 9 203 999,00 for Delivery, installation and commissioning of facilities for prevention and response to operational and emergency pollution in the Bulgarian river and sea ports for public transport of national importance.

 All deliveries, subject of the contract, have been made, put into operation and their functionality has been checked.

 Trainings were conducted in the period 19-21.10.2021.

 A final acceptance protocol was signed on 22.10.2021.

 The contract has been fulfilled.





**European Union**

European Structural  
and Investment Funds



**BULGARIAN PORTS  
INFRASTRUCTURE Co.**



OPERATIONAL PROGRAMME  
TRANSPORT AND  
TRANSPORT INFRASTRUCTURE





**European Union**

European Structural  
and Investment Funds

# PROJECTS UNDER IMPLEMENTATION

## PRIORITY AXIS 4



### CONTRACTS SIGNED WITH A CONTRACTOR:

Contract №DEP-20/21.09.2020 with "STEMO IIS" DZZD amounting to BGN 3 492 770,51 for Implementation of an integrated information platform in Bulgarian ports.

⚓ The contract is in the process of implementation, and the activities under it are completed at 80%. Stages 1, 2 and 3 and 4 of the contract have been fulfilled.

⚓ The implementation of Stage 5 "Training" is forthcoming.



**BULGARIAN PORTS  
INFRASTRUCTURE Co.**





**European Union**  
European Structural  
and Investment Funds

# PROJECTS UNDER IMPLEMENTATION

## PRIORITY AXIS 4



### CONTRACTS SIGNED WITH A CONTRACTOR:

 Contract № DEP-3/15.03.2021 with “DMI Development” Ltd amounting to BGN 19 980,00 for Measures for publicity, information and communication under project BG16M1OP001-4.001-0015

 The contract is in the process of implementation, a public event was held on 20.04.2021, announcing the start of the project. Media monitoring of the project has been prepared, temporary information billboards have been installed.

Total verified project expenditures as of 15.11.2021: 9 591 268,23 BGN





**European Union**

European Structural  
and Investment Funds

# PROJECTS UNDER IMPLEMENTATION

## PRIORITY AXIS 5



**BG16M1OP001-5.001-0025** Specialized trainings to increase the capacity of the employees of the Bulgarian Ports Infrastructure Company (BPI Co.) as Beneficiary under Operational Programme on Transport and Transport Infrastructure (OPTTI) 2014-2020

**Grant Contract №:** DOPTTI-6 of 17.09.2019

**Grant amount:** 973 700,00 BGN

**Term of Project completion:** 30.07.2022

**Main objective of the Project:** To increase the capacity of the Port Infrastructure Manager employees involved in the process of preparation, implementation, management and monitoring of OPTTI projects.



**BULGARIAN PORTS  
INFRASTRUCTURE Co.**



**European Union**

European Structural  
and Investment Funds

# PROJECTS UNDER IMPLEMENTATION

## PRIORITY AXIS 5



### CONTRACT SIGNED WITH A CONTRACTOR:

Contract № DEP-5/30.04.2020 with “Training Pro” DZZD amounting to BGN 883 700,00 for Conducting specialized trainings to increase the capacity of the employees of the Bulgarian Ports Infrastructure Company.

Currently:



Activity 1. "Conducting general and specialized trainings, working meetings and study visits for the employees of BPI Co.": 33 trainings out of the set 74 thematic events - trainings, working meetings and study visits for employees of BPI Co. were conducted;



Activity 3. "Information and communication" the Contractor has prepared the necessary materials for conducting the trainings.

The percentage implementation of the project is 45%.

As a result of the implementation of the project, 80 employees of the BPI Co. will be trained, which is almost 25% of the personnel of the Company.

Total verified project expenditures as of 15.11.2021: 373 513.69 BGN



**BULGARIAN PORTS  
INFRASTRUCTURE Co.**

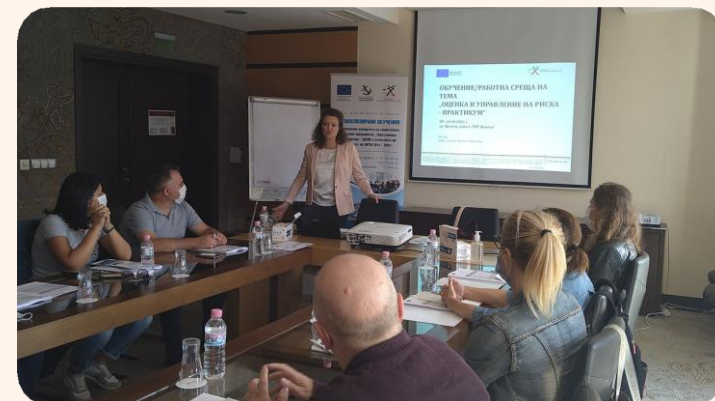



**European Union**

European Structural  
and Investment Funds

## PROJECTS UNDER IMPLEMENTATION PRIORITY AXIS 5



**BG16M1OP001-5.001-0026** Provision of technical assistance for project preparation for the next programming period 2021-2027

**Grant Contract No:** DOPTTI-4 of 06.08.2020

**Grant amount:** 2 671 900,00 BGN

**Term of Project completion:** 31.10.2023

**Main objective of the Project:** Support for the Bulgarian Ports Infrastructure Company in the preparation of projects for the next programming period.



**BULGARIAN PORTS  
INFRASTRUCTURE Co.**



**European Union**  
European Structural  
and Investment Funds

# PROJECTS UNDER IMPLEMENTATION PRIORITY AXIS 5



### CONTRACT SIGNED WITH A CONTRACTOR:

Contract № DEP-4/31.05.2021 r. with “BULGARIAN CONSULTING ORGANIZATION“ EOOD amounting to  
BGN 2 099 960,00 .  
Term of the contract – 30.09.2023



**BULGARIAN PORTS  
INFRASTRUCTURE Co.**







**European Union**  
European Structural  
and Investment Funds

## PROJECTS UNDER IMPLEMENTATION PRIORITY AXIS 5



The scope of the project envisages the implementation of the following activities for preparation of future projects, according to a prioritized and supplemented list of BPICo:

-  Preparation of feasibility studies for the implementation of up to 9 projects;
-  Preparation of Cost-Benefit Analyzes/Analysis of the socio-economic efficiency of projects/Cost-effectiveness analysis or other similar analysis applicable for the 2021-2027 programming period for up to 9 projects;
-  Preparation of documents related to the environmental procedures and in particular to the activities related to the implementation of the preventive mechanisms for environmental protection (EIA) for the projects envisaged for financing for the 2021 - 2027 programming period (where applicable);
-  Preparation of documents (including application forms and technical specifications) required for application for up to 9 projects, according to the adopted regulations and directives for the 2021-2027 programming period.

**Total verified project expenditures as of 15.11.2021: 35 329,10 BGN**



**European Union**  
European Structural  
and Investment Funds

# PLANNED PROJECTS FOR THE PROGRAMMING PERIOD 2021-2027



Development and implementation of a system for electronic data exchange in the Bulgarian ports (Port Community System - PCS)

A contract was concluded № DEP-4/24.04.2020 with the selected contractor ACTUAL-I.T.INFORMATION TECHNOLOGIES EAD in the amount of BGN 8,920,911.00 without VAT, with a term of implementation of 24 months.

Implementation by activities:

 Activity 1: Development of a system project - the activity is completed.

 Activity 3: Implementation of specialized Software - the activity is in the process of implementation.

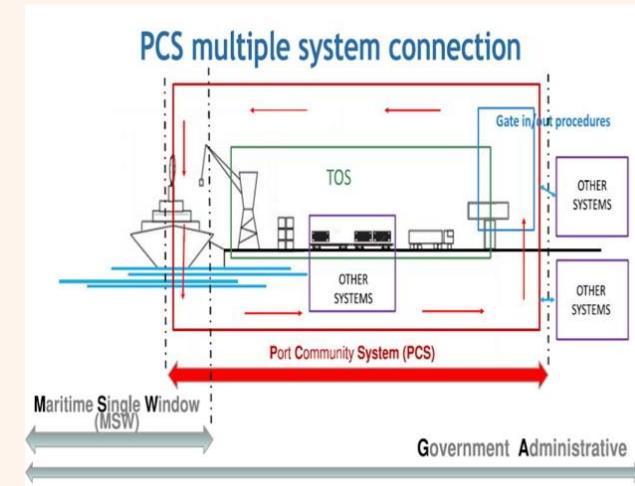



**European Union**

European Structural  
and Investment Funds

# THANK YOU FOR YOUR ATTENTION!



OPERATIONAL PROGRAMME  
TRANSPORT AND  
TRANSPORT INFRASTRUCTURE



**Anna Natova**

**Director Project Management Directorate  
Bulgarian Ports Infrastructure Co.**